

**auto  
motor  
and sport**

**FALLER** 

INSTRUCTION  
**4005**

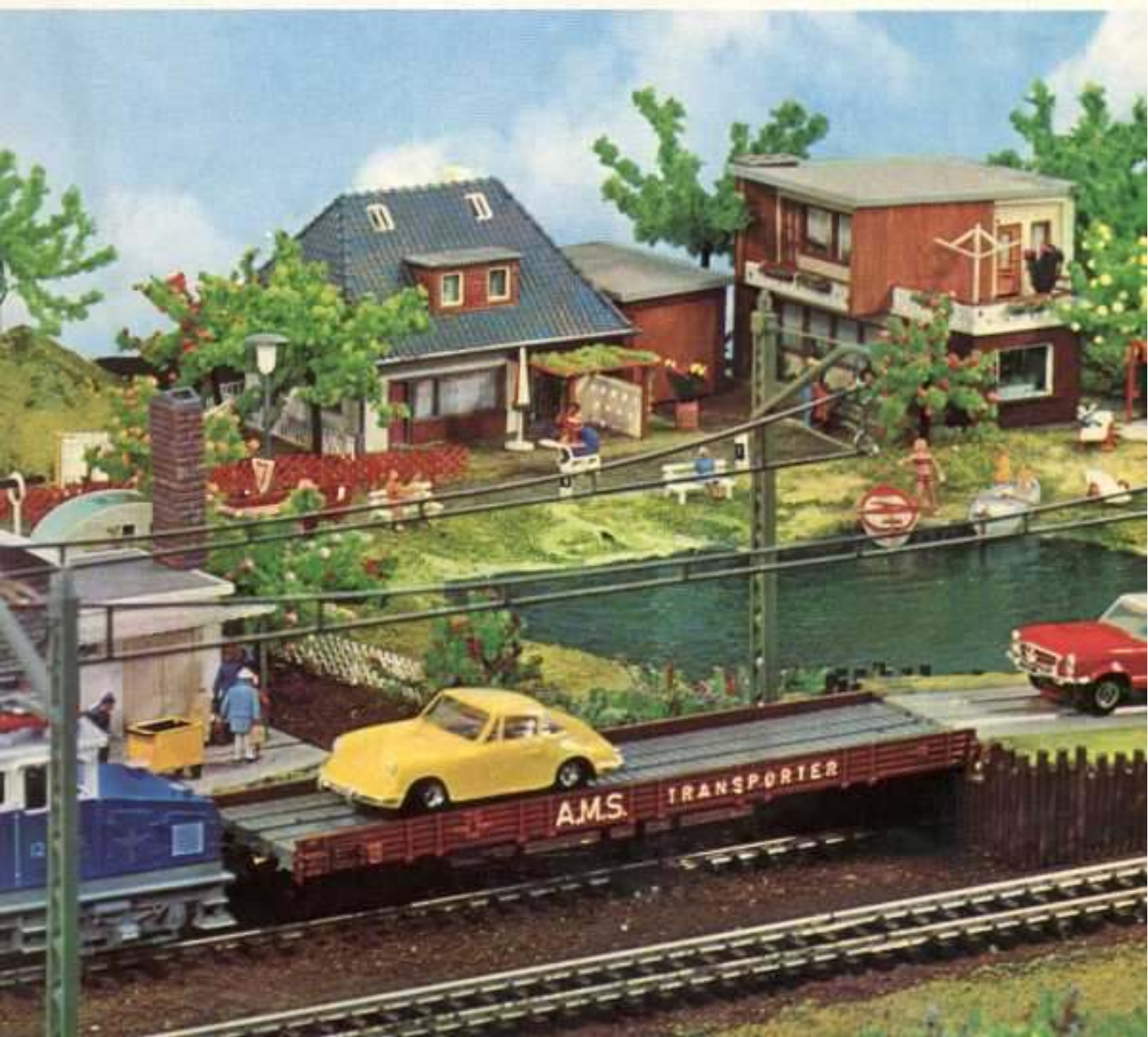





Fig. 1



Fig. 2

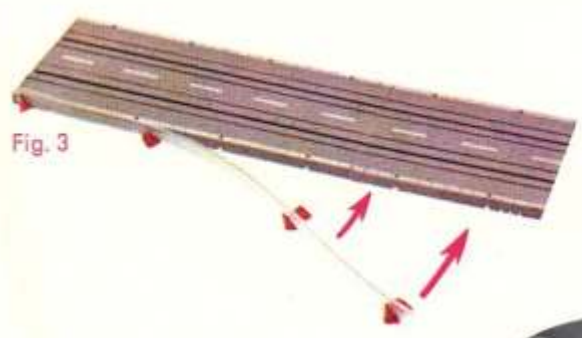

Fig. 3



Fig. 4

12-16 V~



Fig. 5

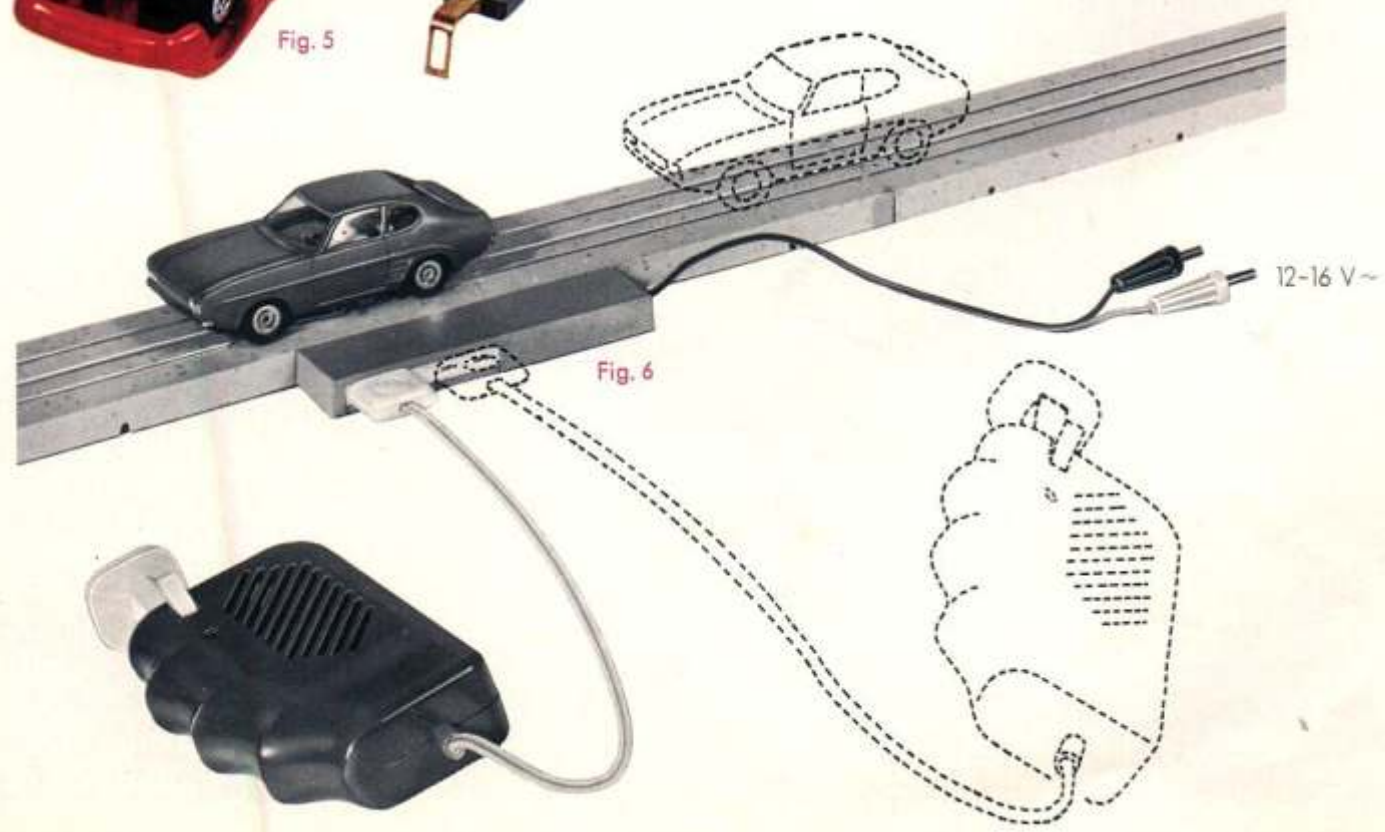

Fig. 6

12-16 V~

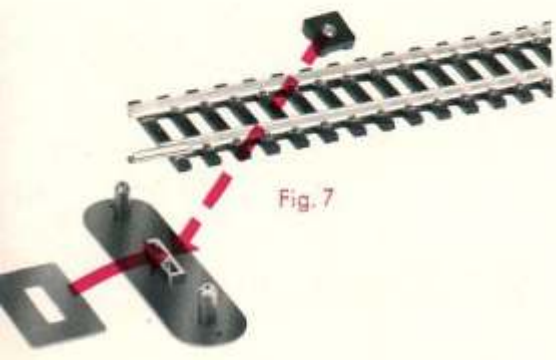

Fig. 7

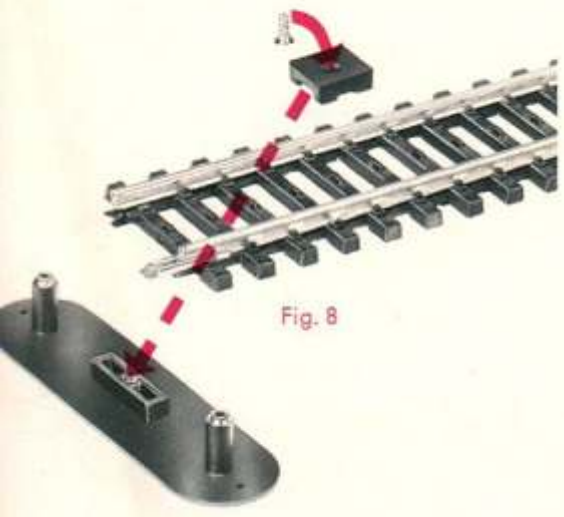

Fig. 8

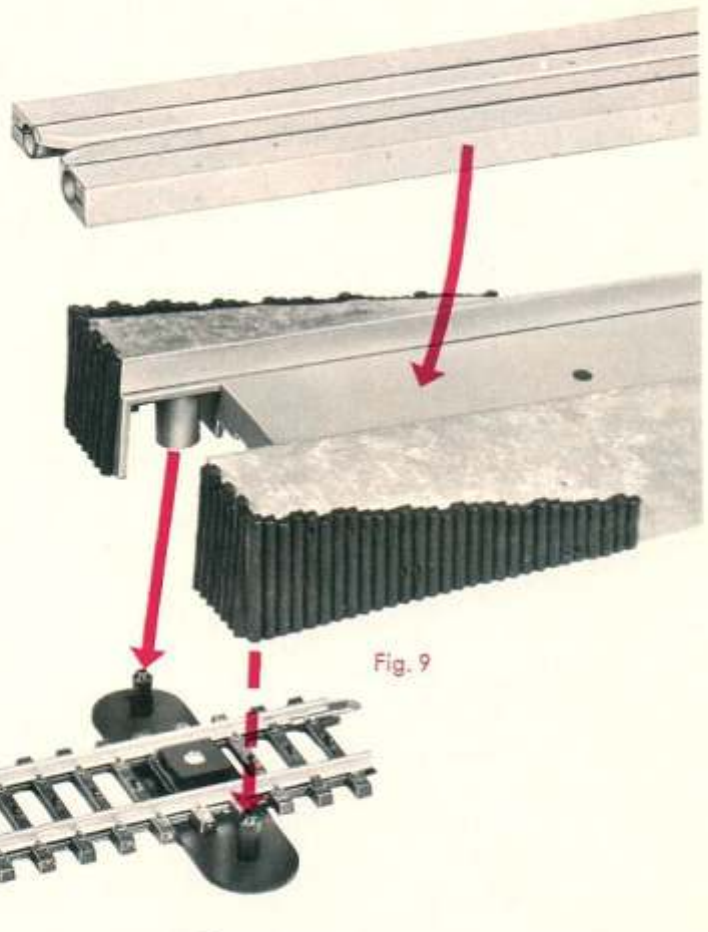

Fig. 9

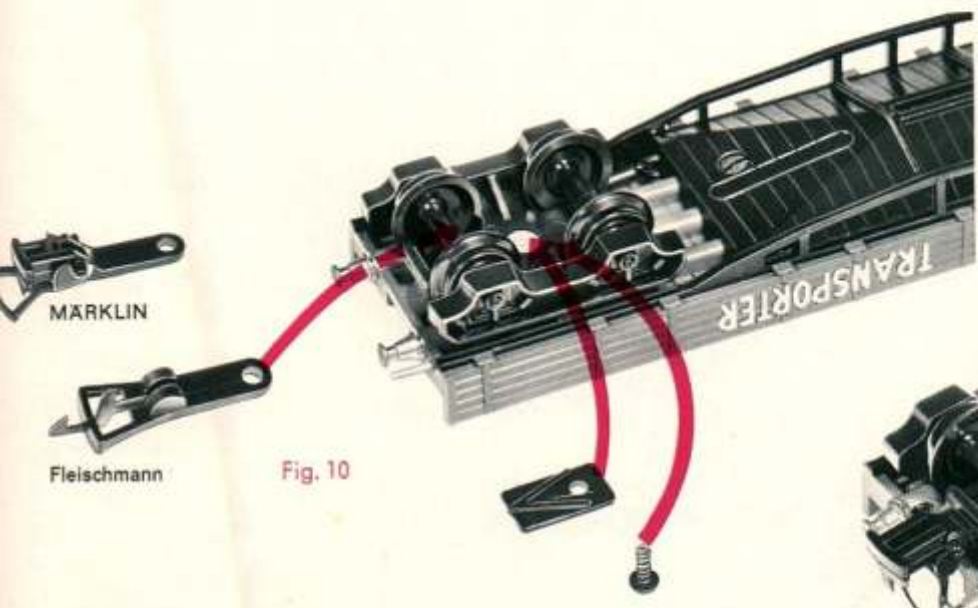

Fig. 10

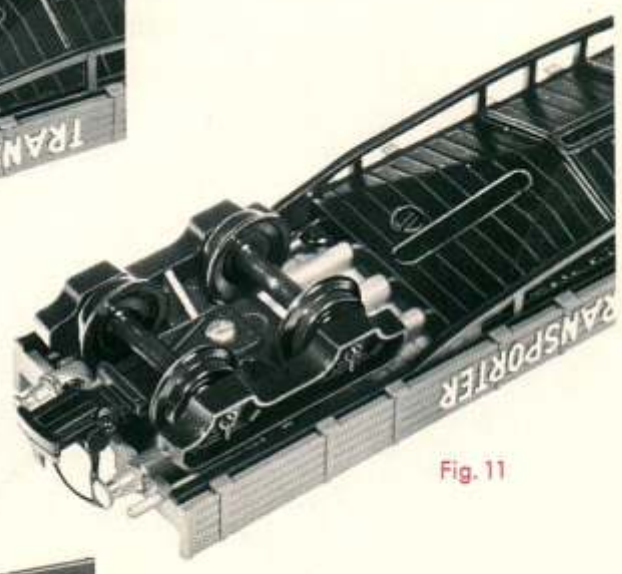

Fig. 11

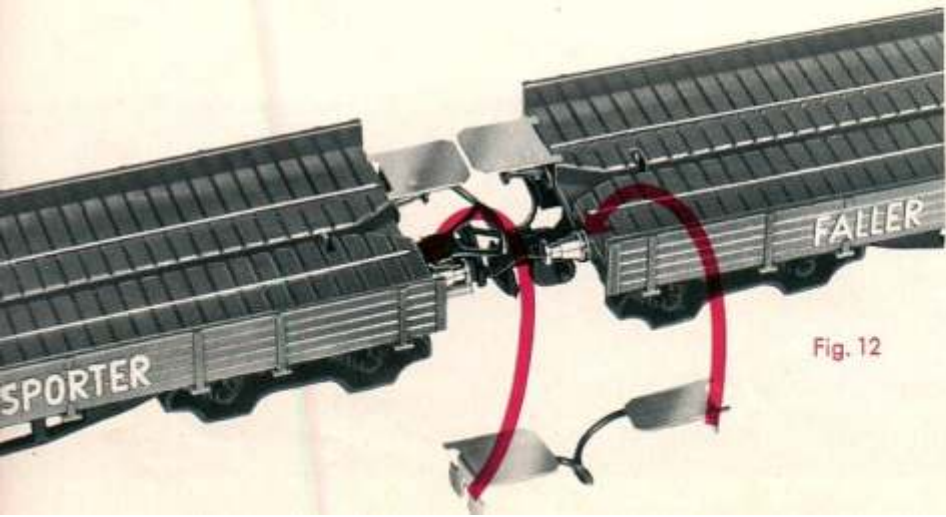

Fig. 12





Fig. 13

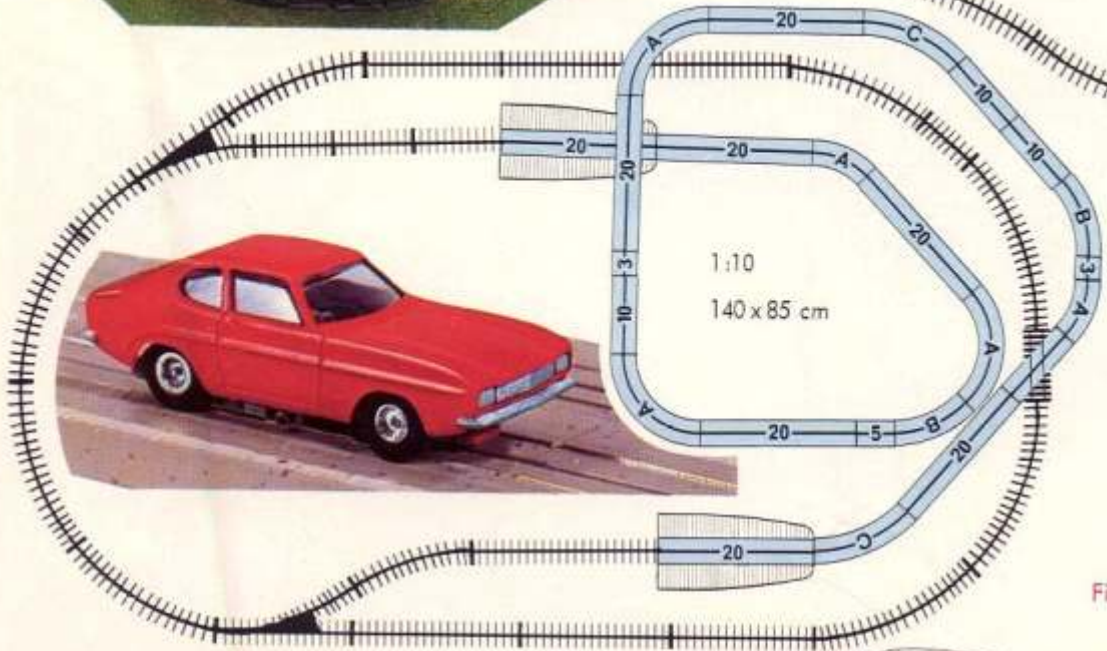
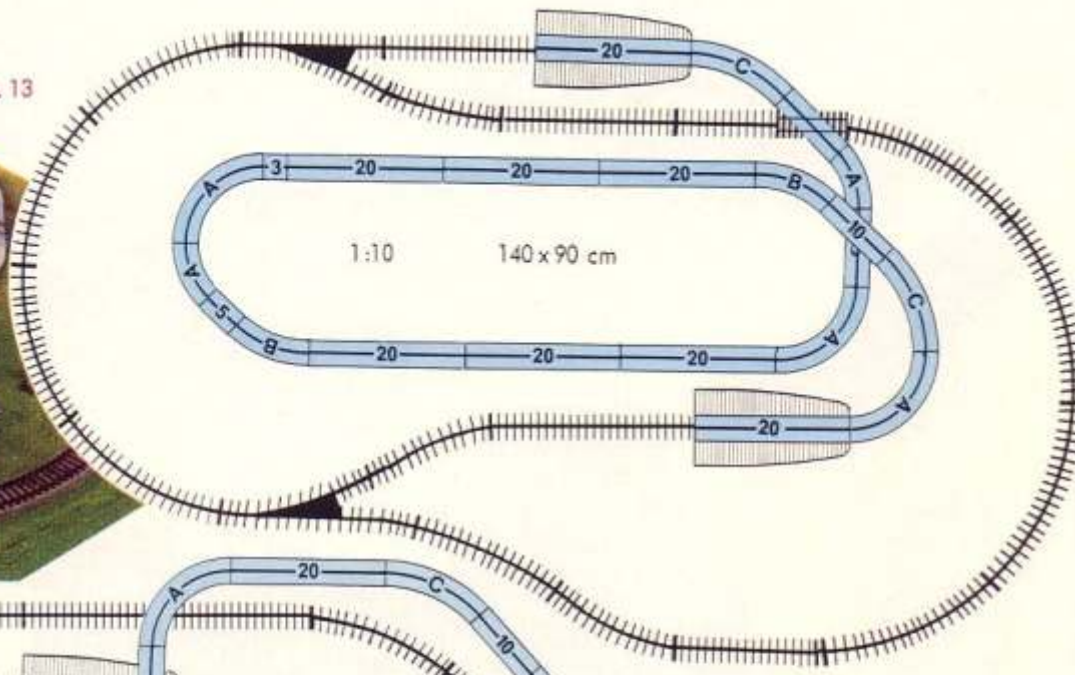

Fig. 14





**4005 +**  
 1 x 4556  
 1 x 4558

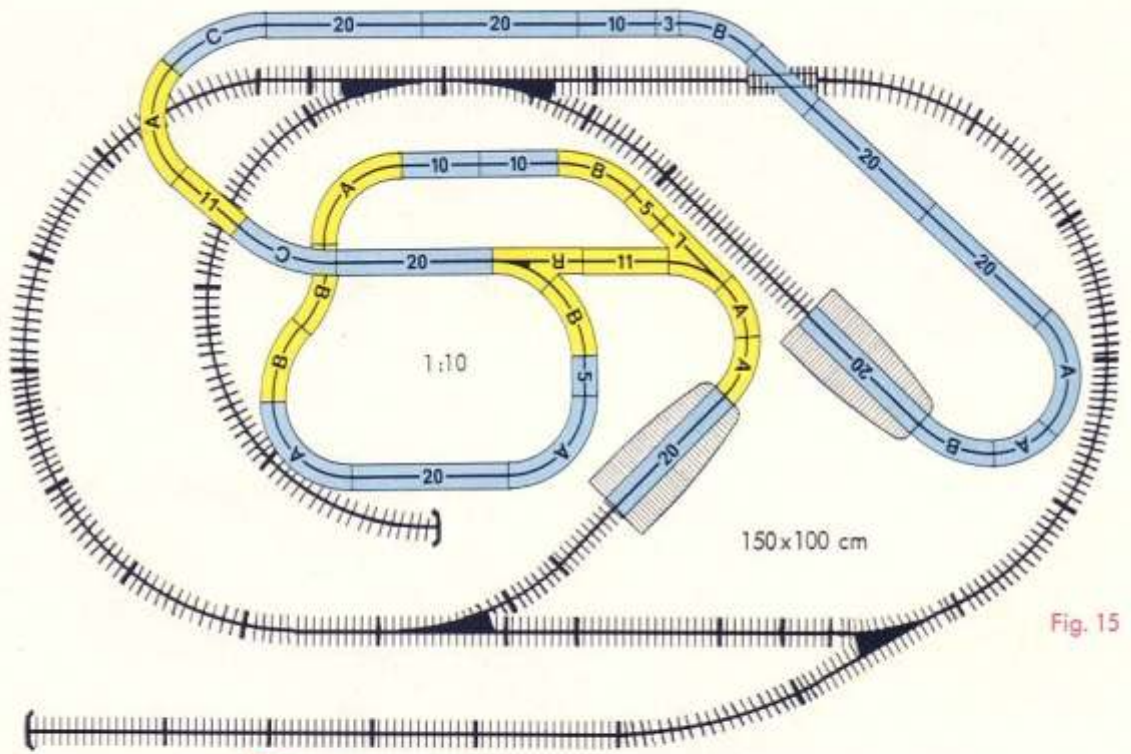

Fig. 15



**4005 +**  
 1 x 4556  
 1 x 4557  
 2 x 4558

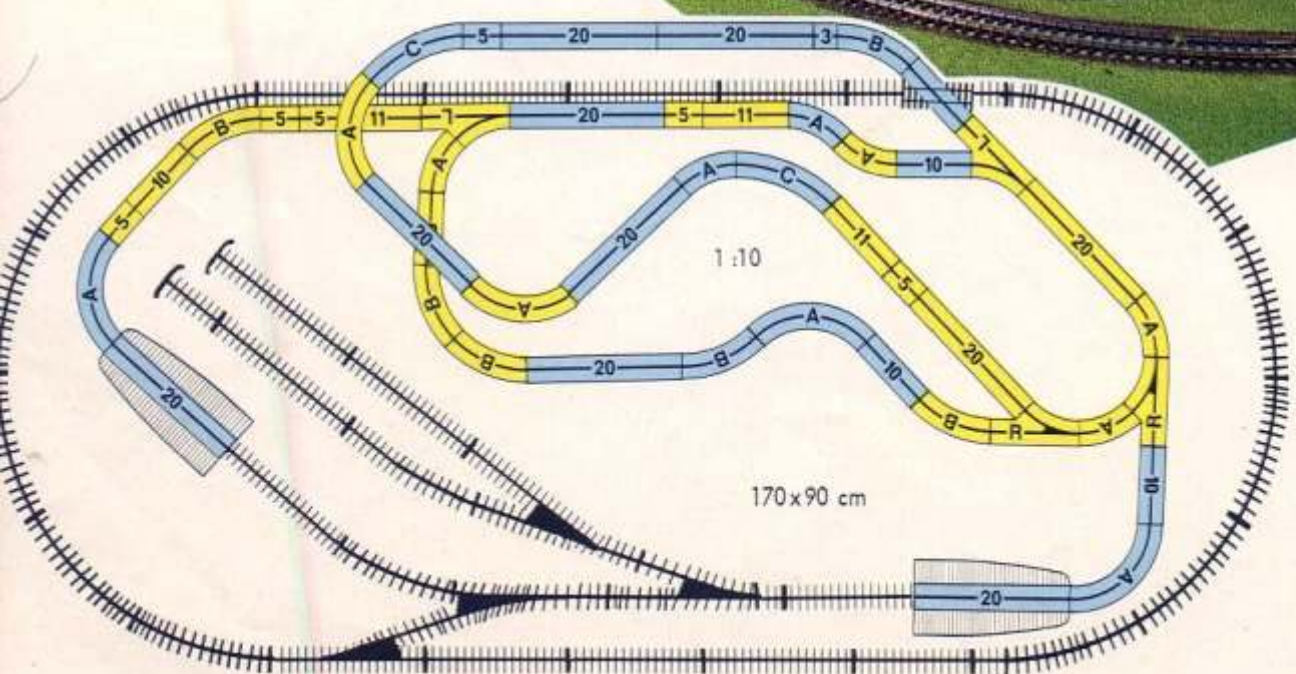

Fig. 16





4005 +  
4003  
1 x 4245  
2 x 4710

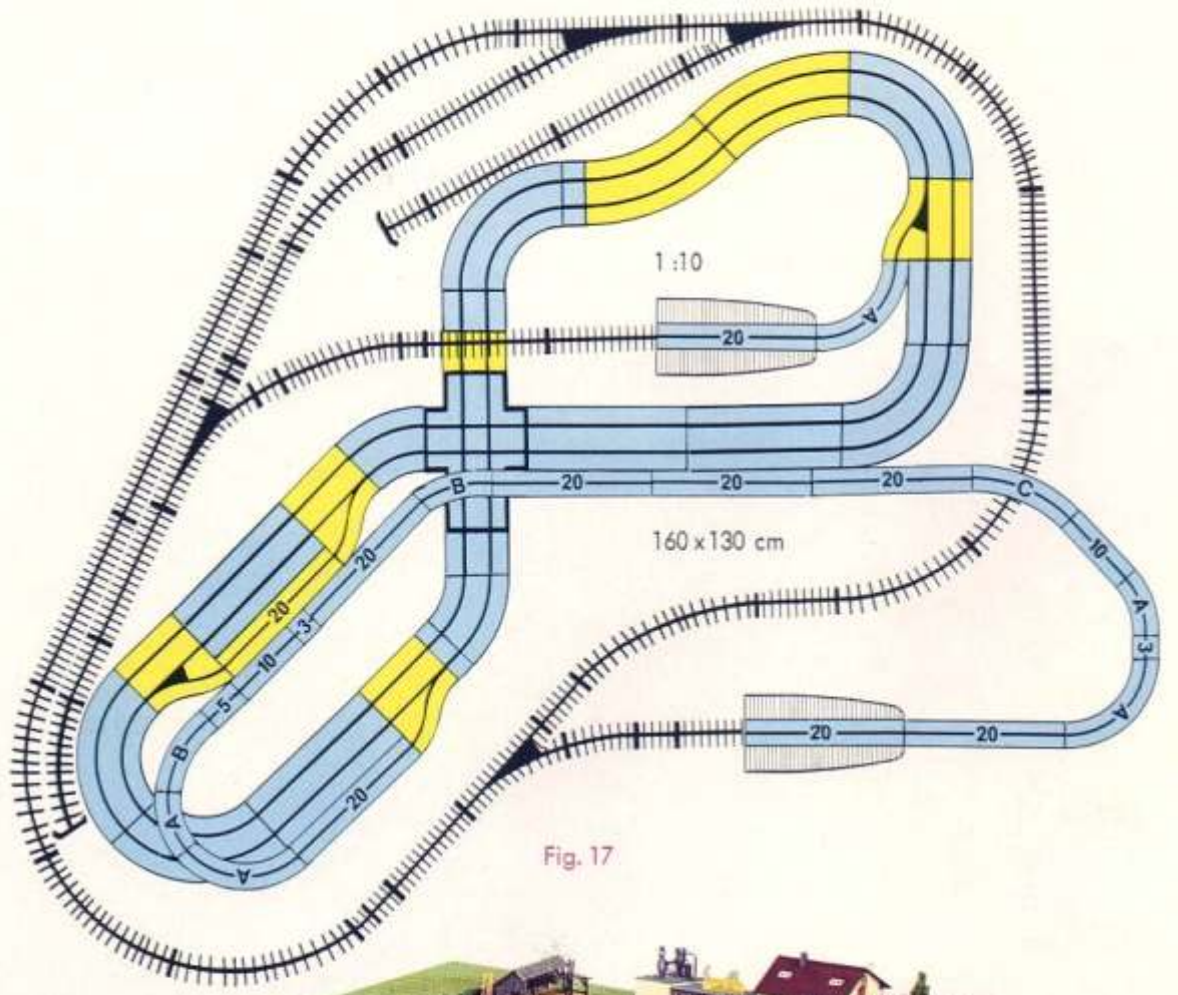
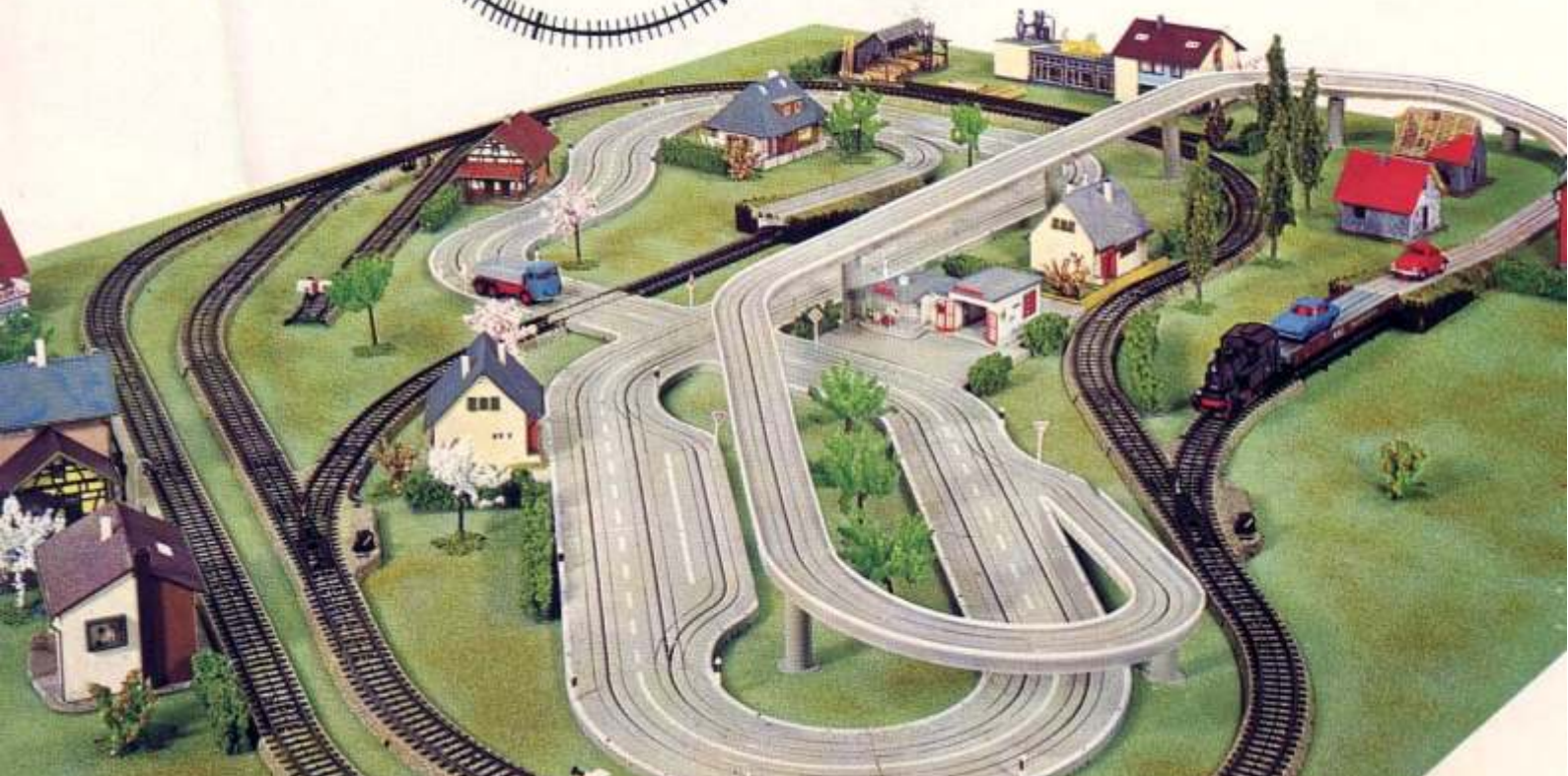
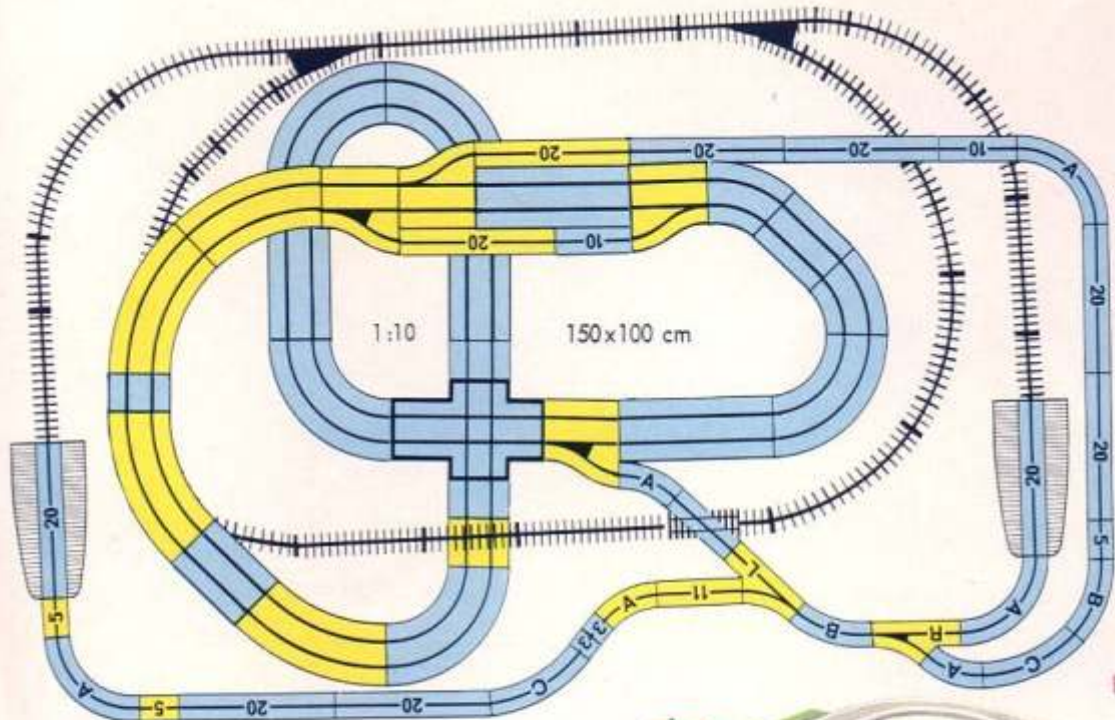

Fig. 17







- 4005 +
- 4003 +
- 2 x 4245
- 1 x 4558
- 2 x 4710
- 1 x 4731

Fig. 18



- 4005 +
- 4003
- 2 x 4245
- 1 x 4556
- 1 x 4558
- 2 x 4710
- 1 x 4731

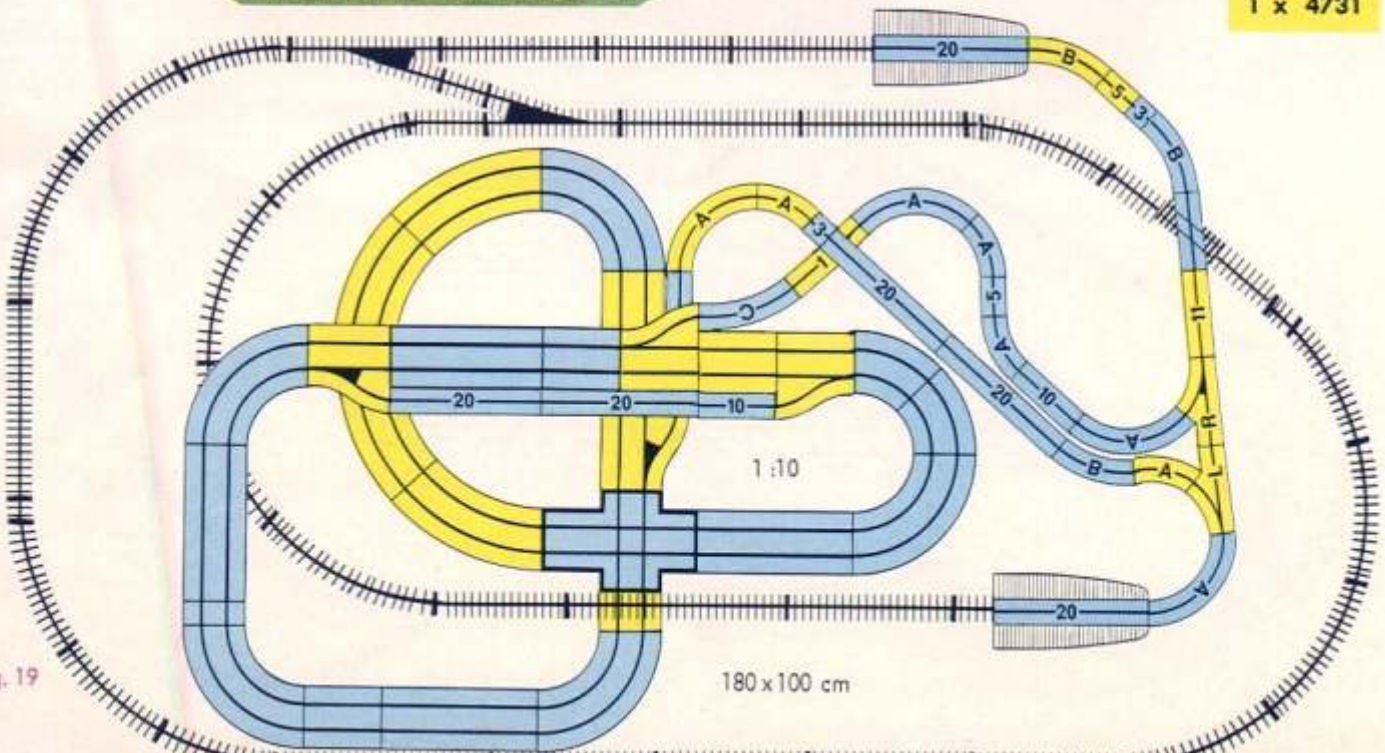
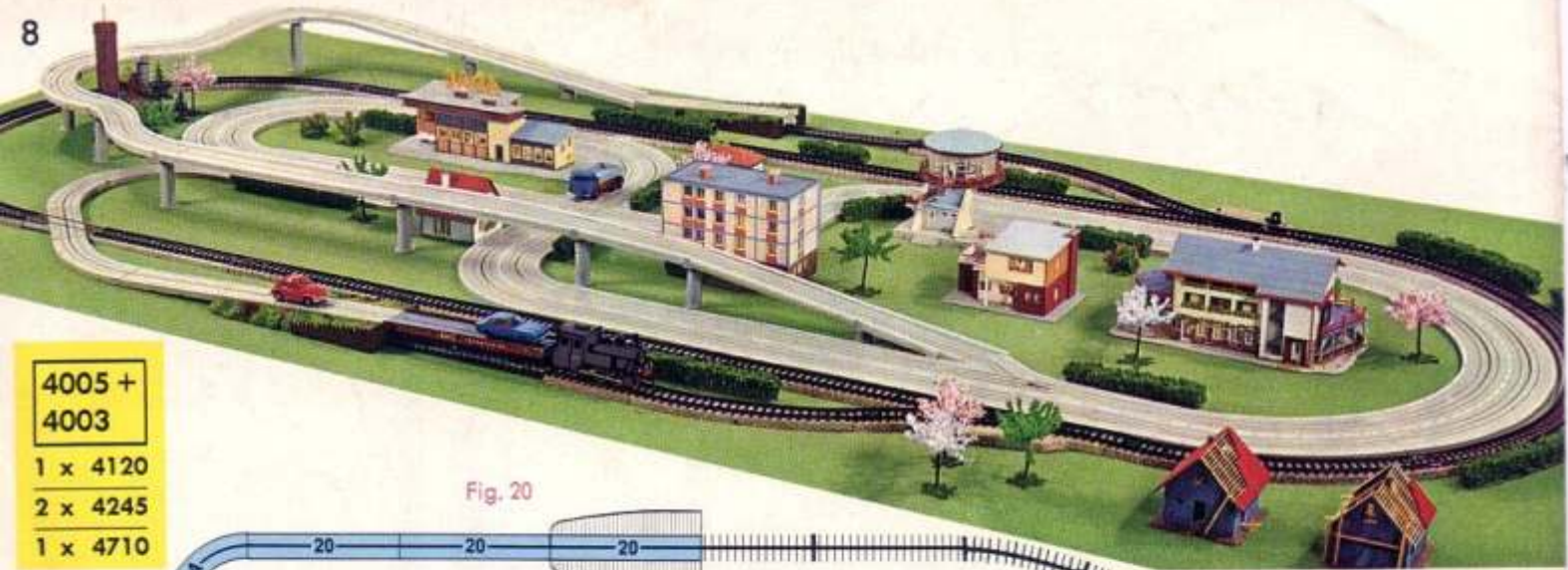

Fig. 19

180x100 cm





- 4005 +
- 4003
- 1 x 4120
- 2 x 4245
- 1 x 4710

Fig. 20

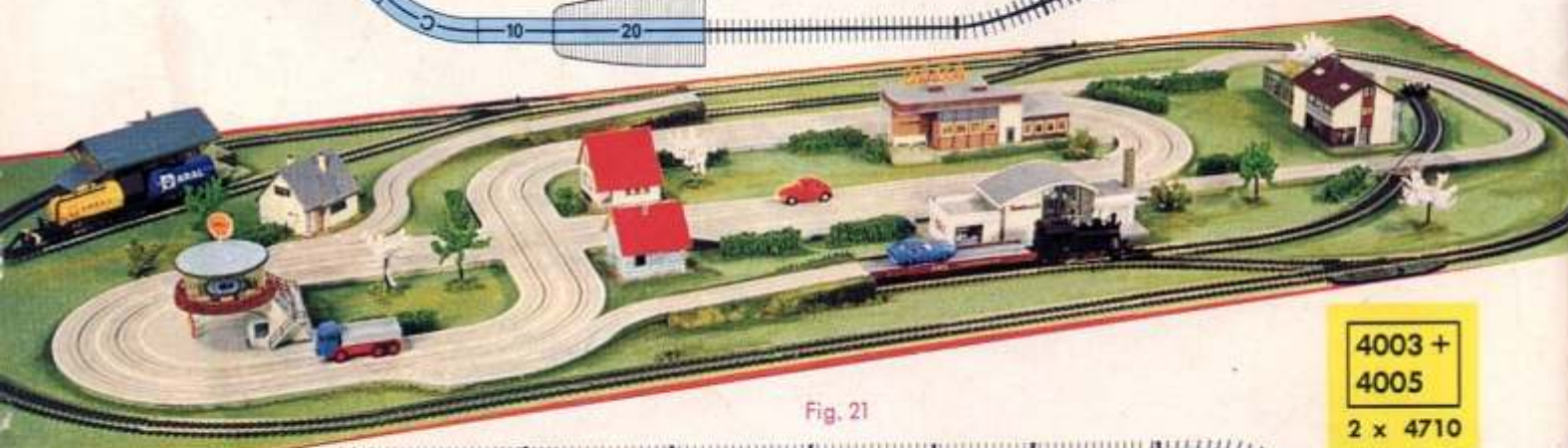
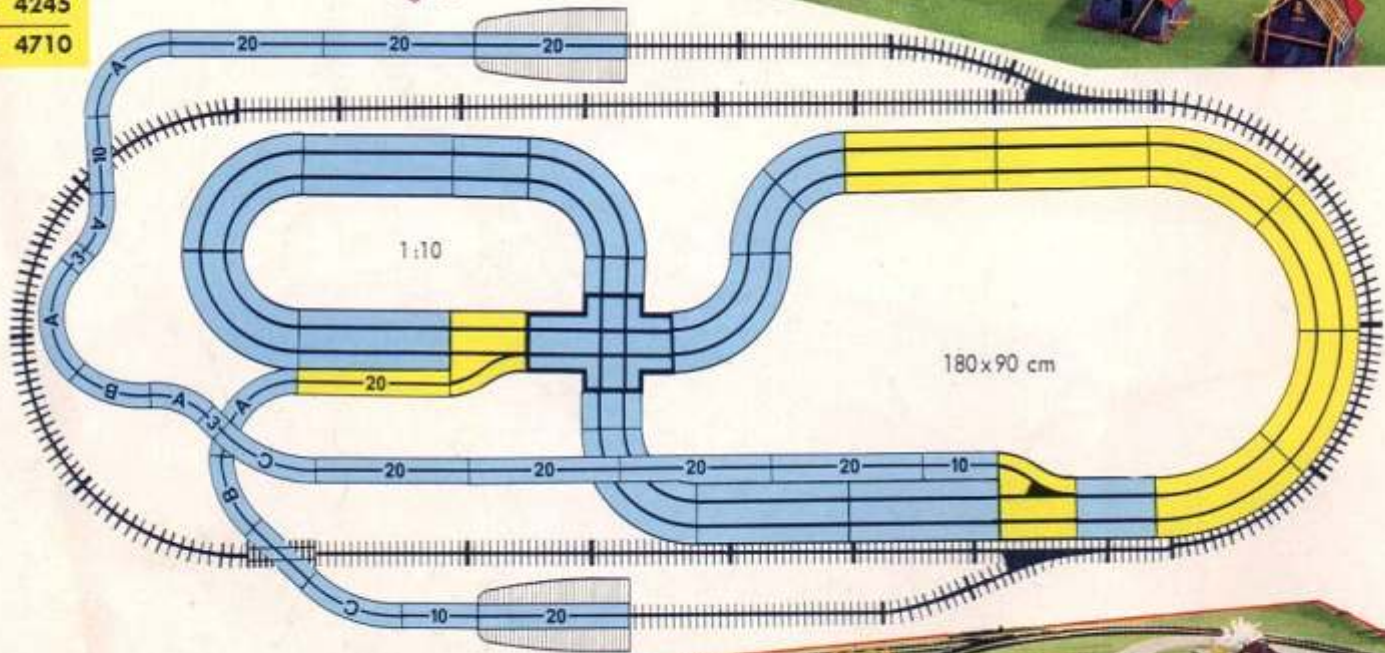

- 4003 +
- 4005
- 2 x 4710

Fig. 21

